

COMTELCO

Technical Specification

BSAX2400-14-120

2.4-2.5GHz 14dBi Gain 120° Sector

BASE STATION ANTENNA

Reliable Performance: Rated at 250 watts and 14dBi gain, you can expect years of continuous service. This antenna provides 120° coverage.

Rugged Construction: The radiating elements are constructed of copper & copper alloy. They are encased in a ABS radome for total environmental protection. The assembly is designed to withstand winds of over 125 MPH.

Weatherproof: The ABS radome is ultraviolet inhibited. The reflector assembly is epoxy powder coated aluminum for superior weather protection.

Installation: All hardware for installation on an existing 2½" diameter mast or tower leg is supplied. The supplied mount kit consists of downtilt adjustable heavy duty aluminum V block and stainless steel V bolts.

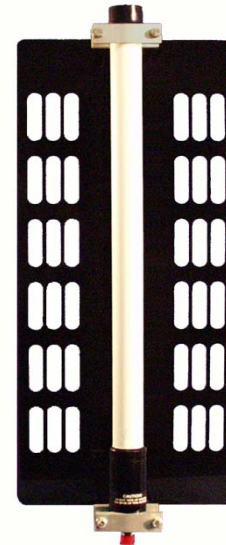

Horizontal Pattern

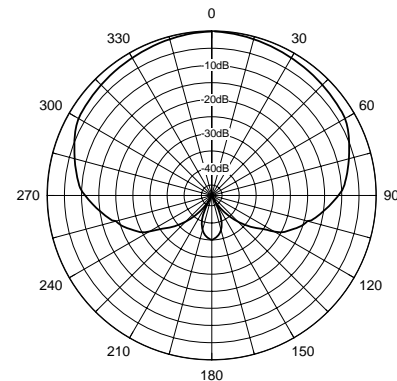

Vertical Pattern

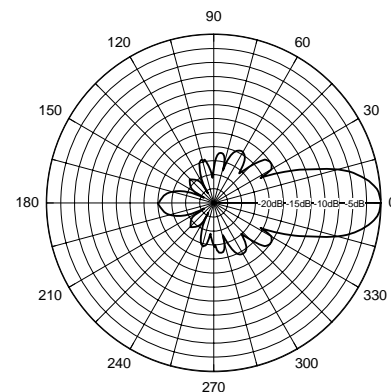

ELECTRICAL SPECIFICATIONS:

FREQUENCY:	2.4 – 2.5 GHz
GAIN:	14dBi
VSWR:	<2:1
BANDWIDTH:	>100 MHz
FRONT TO BACK:	32 dB
POWER RATING:	250 watts
IMPEDANCE:	50 ohms
VERT BEAMWIDTH:	20°
HORIZ BEAMWIDTH:	120°

MECHANICAL SPECIFICATIONS:

RADIATOR:	Internal copper alloy elements
REFLECTOR ASSY:	Powder coated Aluminum 25" H x 10" W
RADOME:	White UV inhibited ABS
TERMINATION:	Female N
HEIGHT:	25"
WIDTH:	10"
WEIGHT:	6 lbs.
FLAT PLATE AREA:	1.32 ft ²
WIND RATING:	125 MPH
LATERAL THRUST:	89 lbs.
MOUNTING:	Stainless V Bolts, Aluminum V Block 2 ½" Dia. Max.